

PTC® CREO® ESSENTIALS PACKAGES

Powerful 3D CAD solutions optimized for your product development tasks

Product design firms and manufacturing companies are under constant pressure to develop more products in less time, without sacrificing innovation or quality.

PTC's 3D product design solution, PTC Creo, provides engineers with the right tools to achieve the highest quality designs in the fastest possible time.

PTC delivers the most scalable range of 3D CAD product development packages on the market today. Available exclusively through PTC Value Added Resellers, the PTC Creo Essentials Packages are easy to use, competitively priced and always upgradeable—to meet the varied needs

of your specific engineering design tasks and business requirements as you grow.

No matter which package you choose, users will be able to take advantage of a powerful, intuitive, and comprehensive set of 3D CAD capabilities.

And since it is an integral part of PTC's Product Development System, your 3D CAD solution will seamlessly connect to PTC's other industry-leading solutions, including PTC Windchill® for product data/product lifecycle management (PDM/PLM) and PTC Mathcad® for engineering calculations.



3D Part & Assembly Design

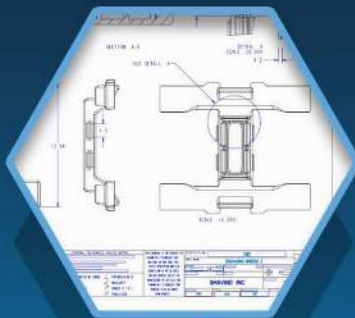

Automated 2D Drawing Creation



Assembly Performance



Unite Technology

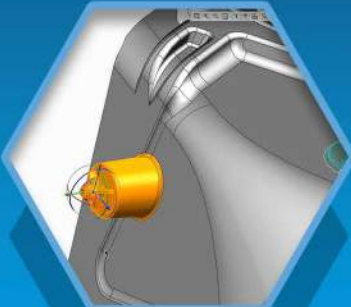

Direct Modeling

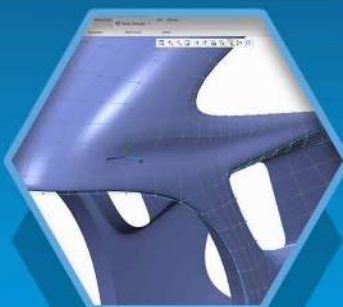

Parametric & Freestyle Surfacing



Realistic Rendering



Mechanism Design

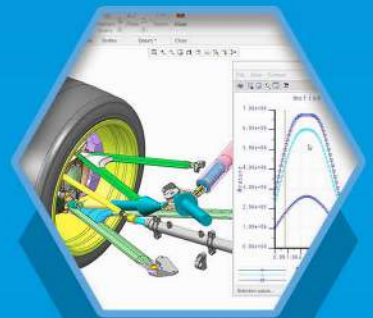

Motion Analysis

PTC® Creo® Essentials

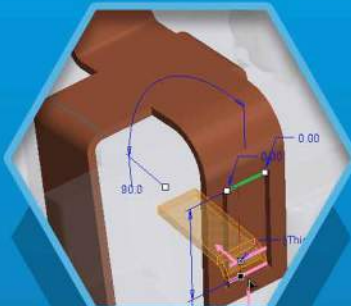

Sheetmetal Design

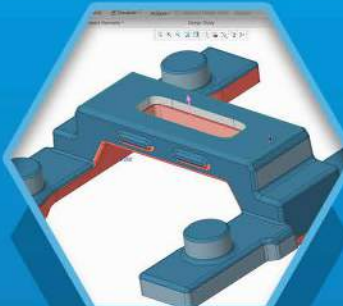

Plastic Part Design

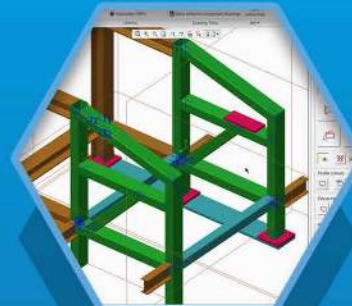

Structure Framework & Weld Design

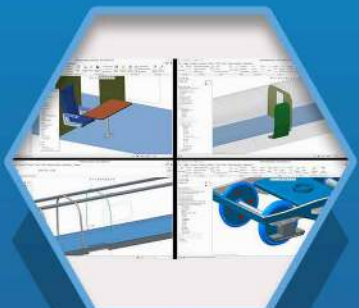

Concurrent Engineering Capabilities



Structural Analysis



Product Data Management

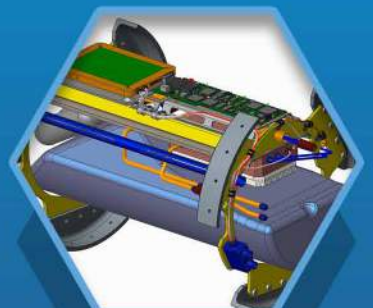

Piping & Cabling Design

PTC Creo Essentials Packages - At a Glance

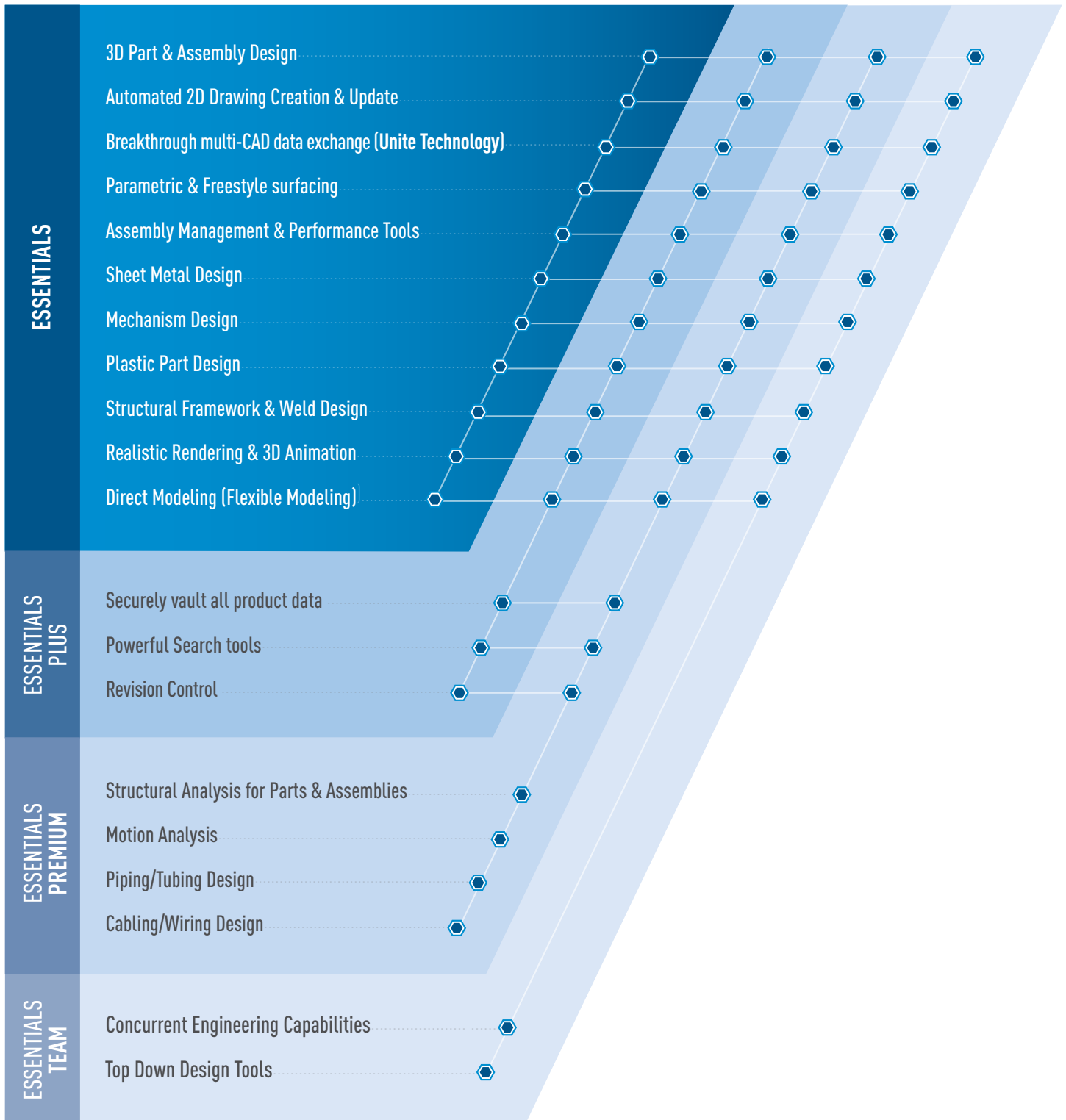

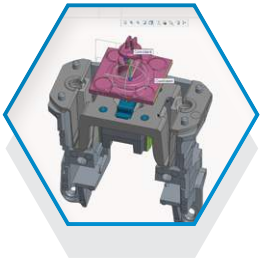

3D Part & Assembly Design

- Create precise geometry, regardless of model complexity
- Quickly build robust engineering features such as rounds, chamfers, holes, and more
- Create design variants using family tables
- Smarter, faster assembly modeling performance
- Static and dynamic interference detection

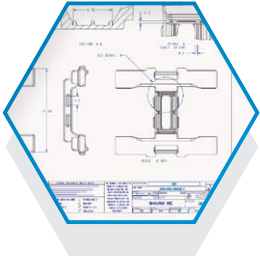

Automated 2D Drawing Creation & Update

- Create 2D and 3D drawings according to international standards, including ASME, ISO and JIS
- Automate the creation of drawings with templates
- Automatically create associative bill of materials with balloon notes

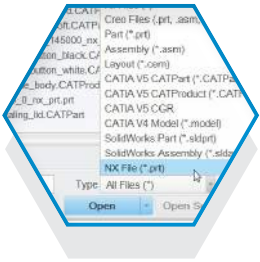

Breakthrough Multi-CAD Data Exchange

- Work with a number of standard file formats including STEP, IGES, DXF, STL, VRML, AutoCAD DWG, DXF (import of 3D with associated 2D), ACIS import/export, Parasolid import/export
- Using Unite technology, convert data from other CAD systems including: CATIA®, Siemens® NX™, SolidWorks®, Autodesk Inventor®, and Solid Edge®
- Incorporate non-PTC Creo data directly into your designs without creating additional business objects or files to manage



Parametric & Freestyle surfacing

- Develop complex surface geometry using sweeps, blends, extends, offsets, and a variety of other specialized features
- Quickly create freeform shapes and surfaces using sub-divisional modeling capabilities
- Multilevel subdivisional modeling for more control over the surface, enabling finer detailing without altering the existing shape
- Parametrically control Freestyle geometry by aligning to existing curves or edges with tangency control



Assembly Management & Performance Tools

- Load large assemblies quickly using lightweight representations
- Create simplified representations 'on-the-fly'
- Share lightweight yet fully accurate model representations using the unique Shrinkwrap™ tool

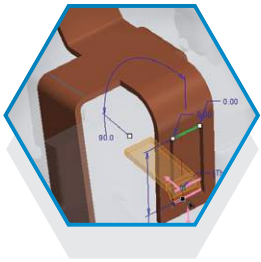

Sheet Metal Design

- Easily create walls, bends, punches walls, bends, punches, flanges, forms, and reliefs using the streamlined user interface
- Automatically generate flat patterns from 3D geometry
- Dynamically preview formed and flattened sheetmetal designs simultaneously
- Easily convert solid parts to sheetmetal
- Simply define sheetmetal design parameters, e.g. bend allowances



Mechanism Design

- Create mechanical connections
- Validate the kinematic motion of your design
- Establish motion envelopes to detect and avoid interferences

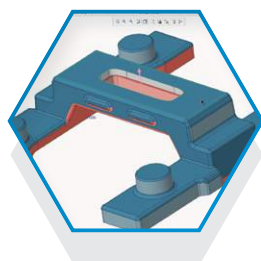

Plastic Part Design

- Comprehensive analysis tools including draft and 3D thickness evaluation
- Mold filling simulation capabilities
- Integrated measurement tools

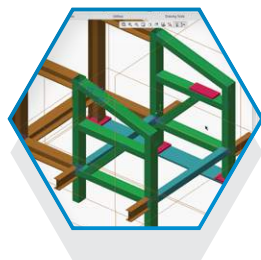

Structural Framework & Weld Design

- Optimized user interface for the structural framework design process
- Extract valuable information from the model, such as mass properties, clearances, interferences, and cost data
- Easily produce complete 2D weld documentation



Realistic Rendering and 3D Animation

- Create accurate, photorealistic images of products quickly, while rendering even the largest assemblies
- Shade with reflections for displaying different material classes such as metal, glass, paint, and plastic
- Create assembly/disassembly animations directly from the modeling environment

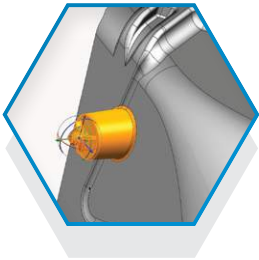

Direct Modeling (Flexible Modeling)

- Make changes to PTC Creo data regardless of design intent
- Modify non-PTC Creo data regardless of origin (Solidworks, STEP, etc...)
- Recognize rounds, chamfers, patterns and symmetry on imported geometry
- Create or recreate design intent and record edits as features



Product Data Management (PDM)

- Secures CAD models, their structures and relationships (PTC Creo, AutoCAD, SolidWorks, Inventor, Pro/ENGINEER, PTC Creo Elements/Direct, and PTC Mathcad) improving control and collaboration. Manage office documents, such as Microsoft Word and Excel, tracking changes through check in and check out functionality
- Embedded 3-D view and markup utilities – Allows non-CAD consumers to view, section, measure and markup designs
- Powerful searching tools – Quickly and easily search, copy or rename designs improving product information discovery and design reuse
- Fast deployment through installation and configuration wizards which greatly simplify set-up time and provide your organization with quicker time-to-value



Structural Analysis for Parts and Assemblies

- Conduct standard linear static analysis on parts and assemblies
- Fast, automatic meshing and solution convergence
- Comprehensive customizable materials library

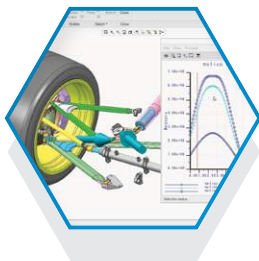

Motion Analysis

- Incorporate springs, dampers, motors, friction, gravity and custom dynamic loads to evaluate product performance
- Use design studies to optimize the mechanism's performance over a range of input variables
- Create accurate motion envelopes for use in interference and space claim studies
- Create high-quality animations directly from dynamic simulations

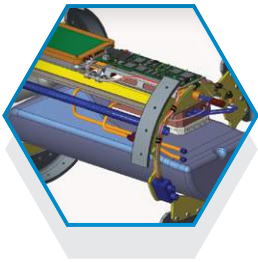

Piping & Cabling Design

- Full routing capabilities, including automated ribbon cabling and specification-driven design and auto-routing, speeds design and adheres to design rules and schematic logic
- Customizable library of standard fittings and connectors
- Manufacturability and interference checking
- Associative harness manufacturing capabilities include automatic development of flat patterns
- Automatic creation of supporting documentation including isometric drawings, bend tables, nail board drawing, associative wire lengths, bills of material

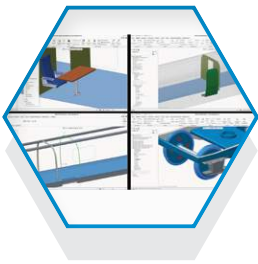

Concurrent Engineering Capabilities

- Establish and enforce design criteria to support concurrent engineering efforts
- Manage and control assembly references and unwanted relationships
- View graphical representation of dependencies to understand component relations and change propagation
- Enhanced capabilities to work with assembly data and manage system performance

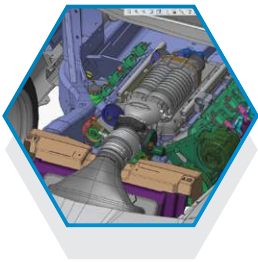

Top Down Design Tools

- Plan assembly structure and manage assembly design process
- Define configuration rules and automate the creation of design-to-order products
- Specialized capabilities to streamline the creation of assembly process planning documentation

© 2014, PTC Inc. All rights reserved. Information described herein is furnished for informational use only, is subject to change without notice, and should not be taken as a guarantee, commitment, condition or offer by PTC. PTC, the PTC logo, Product & Service Advantage, Creo, Elements/Direct, Windchill, Mathcad, Arbortext, PTC Integrity, Servigistics, ThingWorx, ProductCloud and all other PTC product names and logos are trademarks or registered trademarks of PTC and/or its subsidiaries in the United States and other countries. All other product or company names are property of their respective owners.

J4082-PTC-Creo-Essentials-Packages-0814